

WHEN DISASSEMBLING ALUMINUM EXTRUSION, TIGHTEN ALL SETSCREWS AND LOCKS TO PREVENT LOSS DURING SHIPPING

visionary™ IDESIGNS

Using Your Setup Instructions

The Visionary Designs Setup Instructions are created specifically for your configuration. They are laid out sequentially, including an exploded view of the entire display, and then a logical series of detailed steps to assemble the main structure and components. We encourage you to study the instructions **before** attempting to assemble your exhibit.

Each page reminds you to tighten the setscrews after disassembling your exhibit to prevent loss of the locks and setscrews (see below in RED). This is **VERY IMPORTANT**.

Cleaning and Packing Your Display

- 1) Use care when cleaning aluminum extrusion or acrylic inserts. Use only non-abrasive cleaners.
- 2) When cleaning laminate inserts or countertops, use mild cleansers and a soft material such as cotton.
- 3) Keep all display components away from extreme heat and long exposure to sunlight to avoid warping and fading.
- 4) Retain all packing material. It will make re-packing much easier and will reduce the likelihood of shipping damage.



The Tool

Most Visionary Designs exhibits can be assembled with the supplied Hex Key Tool. Occasionally, a flat head screwdriver may be required.



Typical Connection

Most horizontal extrusion connections have a patented expandable lock. This lock inserts into the groove of an opposing extrusion. Tightening the lock with the Hex Key Tool expands the lock and creates a strong positive connection.



Typical Connection (cont'd)

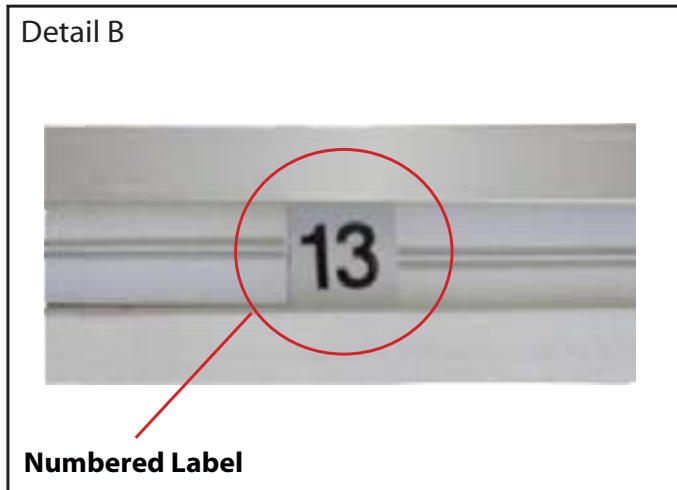

Detail B

Numbered Label

Each extrusion contains a numbered label which corresponds with setup instructions. The label is located within a groove of the extrusion (when possible). With Visionary Designs the labels contain Black numbers unless otherwise specified.



Detail C

Horizontal Inline Connection (remove only one setscrew)

Remove only (1) setscrew when disassembling. Replace setscrew in extrusion after assembling it. Before packing, replace setscrew in extrusion to avoid losing it.

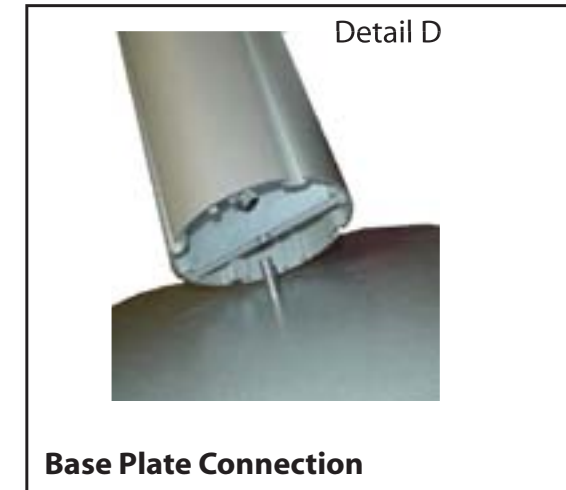

Detail D

Base Plate Connection

Attach base plate to round or square vertical extrusion using the bolt provided. Be careful not to strip the threads.

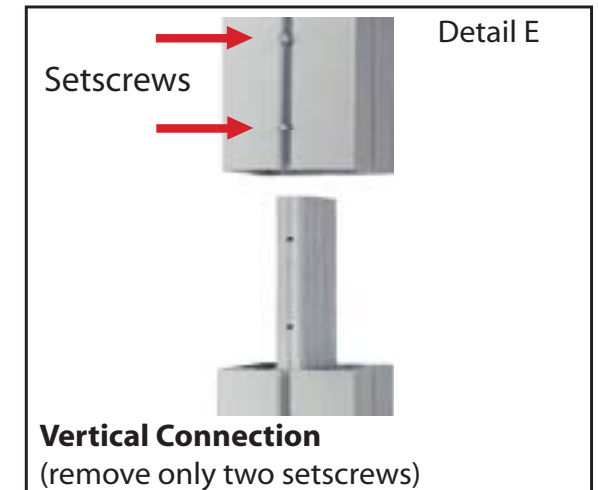

Detail E

Vertical Connection
(remove only two setscrews)

When vertical extrusions are packed in portable cases rather than crates or tubs, they must be broken down into smaller sections which then require assembly.

Remove only (2) setscrews when disassembling. Replace setscrews in extrusion after assembling it. Before packing, replace setscrews in extrusion to avoid losing them.

WHEN DISASSEMBLING ALUMINUM EXTRUSION, TIGHTEN ALL SETSCREWS AND LOCKS TO PREVENT LOSS DURING SHIPPING

866.652.2100

Item	Quantity	Description
1	2	Base Plate
2	1	42" h Vertical Extrusion
2A	1	47.5" h Vertical Extrusion
3	1	42" h Vertical Extrusion
3A	1	47.5" h Vertical Extrusion
4	1	42.125" h Vertical Extrusion
5	1	42.125" h Vertical Extrusion
6	1	38.242" h 90° Horizontal Extrusion
7	1	40.033" h 135° Horizontal Extrusion
8	1	38.242" h 90° Horizontal Extrusion
9	1	40.033" h 135° Horizontal Extrusion
10a/10b	1/1	31.192" h Horizontal Extrusion
11a/11b	1/1	31.831" h 10° Angle Cut One End Horizontal Extrusion

Steps:

- 1) Attach lower vertical extrusions 2 and 2A to base plates 1.
- 2) Connect upper vertical extrusions 3 and 3A to lower vertical extrusions 2 and 2A.
- 3) Attach horizontal extrusion 7 to horizontal extrusion 6 and horizontal extrusion 9 to horizontal extrusion 8 by using V10 Pressure Lock.
- 4) Connect upper vertical extrusion 5 to lower vertical extrusion 4.
- 5) Connect horizontal extrusions 6/7 between vertical extrusions 2 and 4, then connect horizontal extrusions 8/9 between vertical extrusions 3 and 5.
- 6) Connect horizontal extrusions 10a to 10b together and connect horizontal extrusions 11a to 11b together.
- 7) Connect horizontal extrusions 10a/10b between vertical extrusions 4 and 2A, then connect horizontal extrusions 11a/11b between vertical extrusions 5 and 3A.

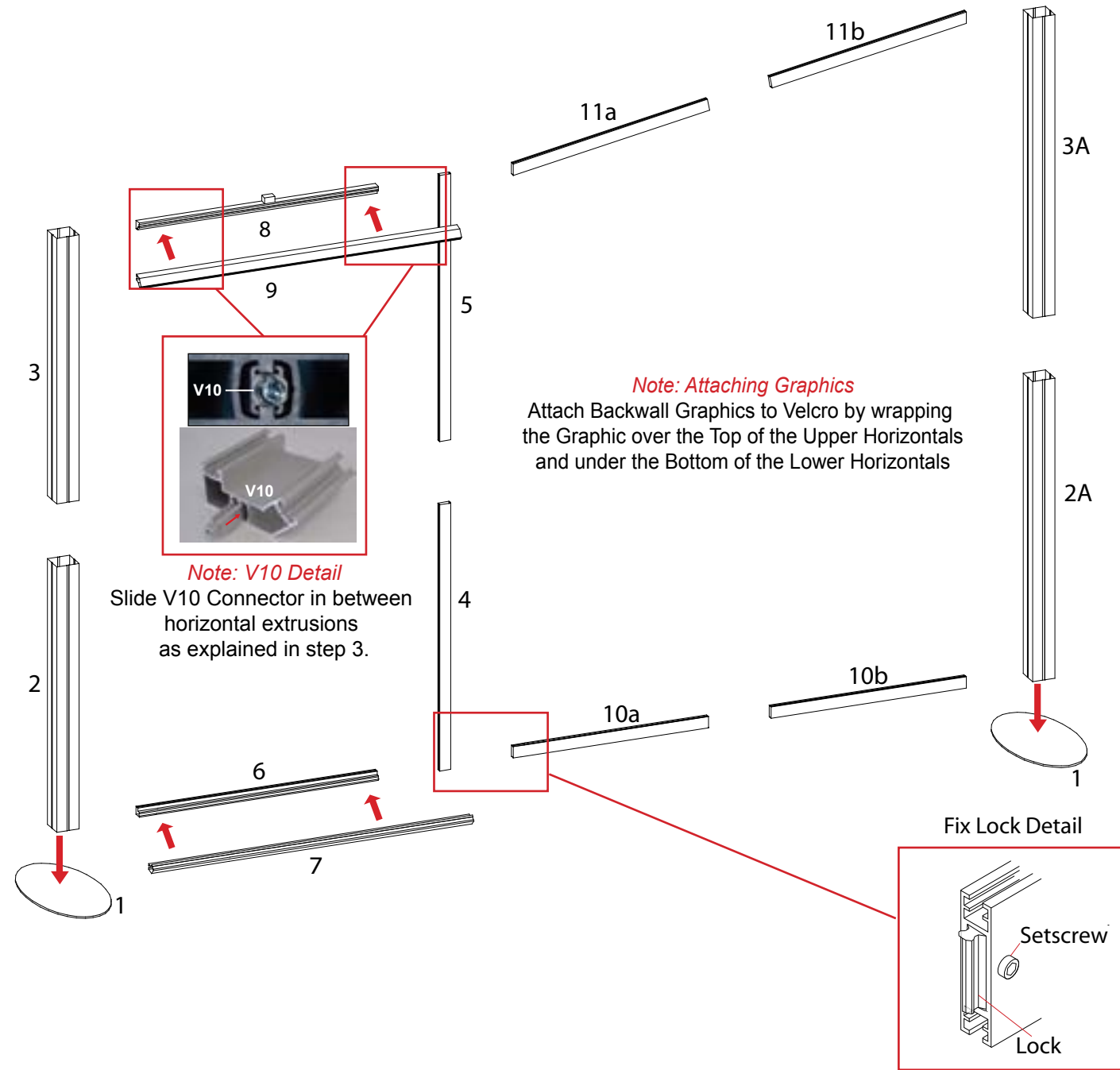

WHEN DISASSEMBLING ALUMINUM EXTRUSION, TIGHTEN ALL SETSCREWS AND LOCKS TO PREVENT LOSS DURING SHIPPING

866.652.2100

Item	Quantity	Description
12	1	Curved Vertical Extrusion
13	1	Curved Vertical Extrusion
14	1	Curved Vertical Extrusion
15	1	Curved Vertical Extrusion

Steps:

- 1) Connect vertical extrusion 12 to vertical extrusion 13 and Connect vertical extrusion 14 to vertical extrusion 15.
- 2) Attach assembled vertical extrusions 12/13 and 14/15 to horizontal extrusions 7 and 11 as shown.
- 3) Attach lights to horizontal extrusions as shown.

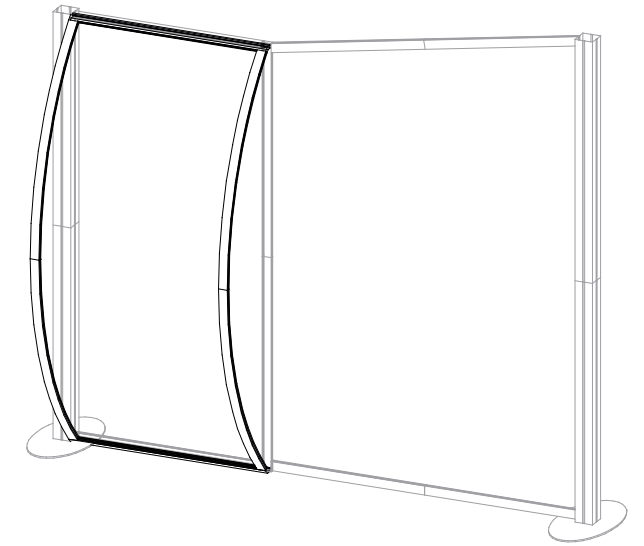
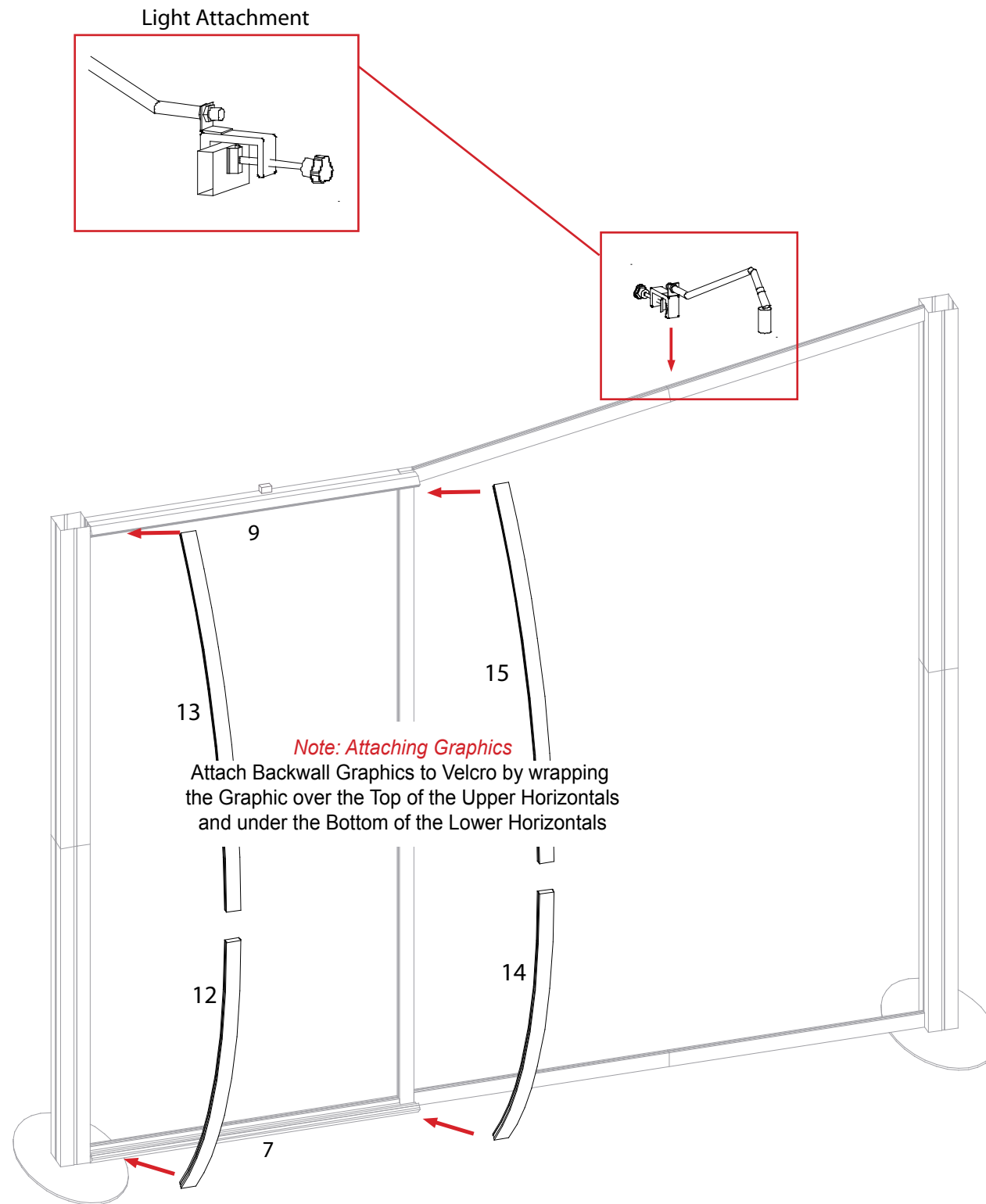

WHEN DISASSEMBLING ALUMINUM EXTRUSION, TIGHTEN ALL SETSCREWS AND LOCKS TO PREVENT LOSS DURING SHIPPING

866.652.2100

Steps:

- 1) Use screw caps to secure the front panel and back panel to the side panels.
- 2) Slide floor into the bottom of the pedestal. The floor will sit on pins set into the side panels.
- 3) Attach shelf supports with velcro to inside of panel.
- 4) Place counter top on assembled pedestal.

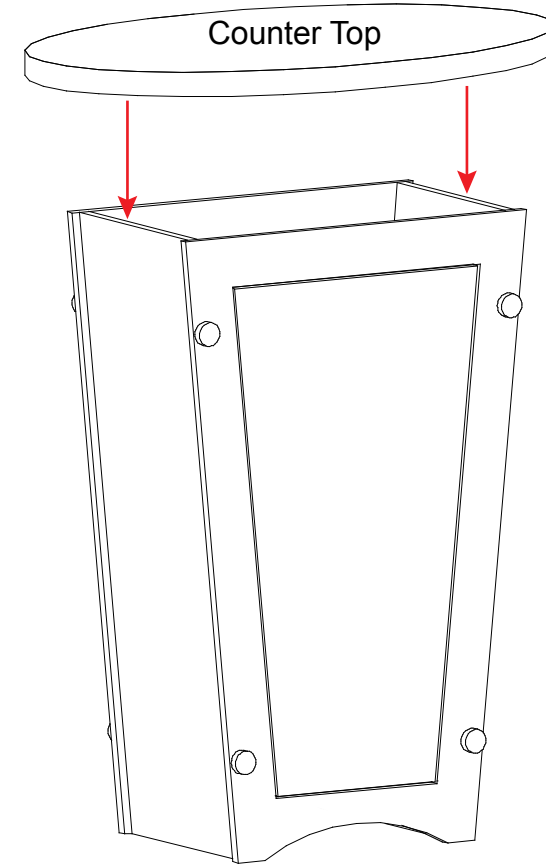
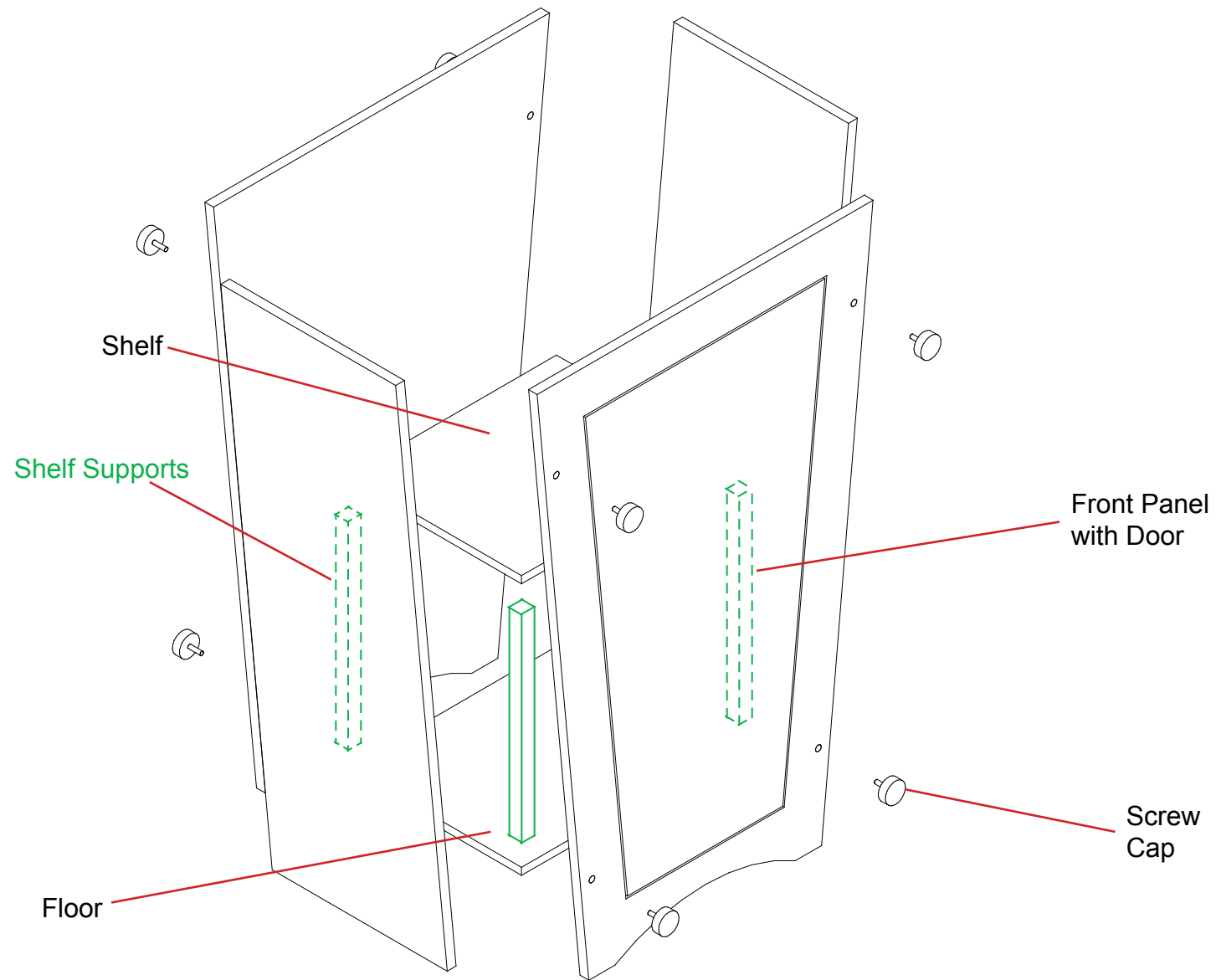
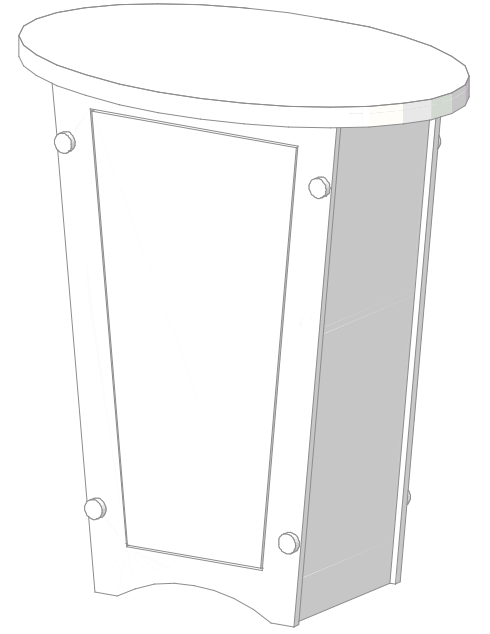

WHEN DISASSEMBLING ALUMINUM EXTRUSION, TIGHTEN ALL SETSCREWS AND LOCKS TO PREVENT LOSS DURING SHIPPING